

UTILIS
multidec[®]
swiss type tools

multidec[®]-**CUT**

G-LINE INSERTS

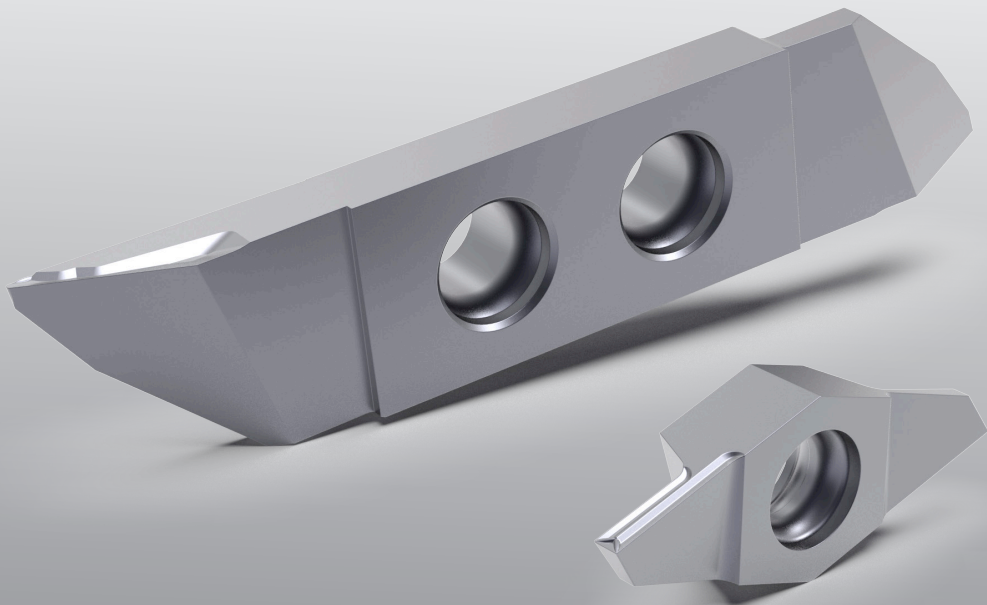

INNOVATION

THE PERFORMANCE BOOST IN MACHINING!

future since **1915**

UTILIS[®]
Tooling for High Technology



Free form chip breakers for small part manufacturing and micro cutting

With a focus on high productivity, process reliability, and the longest possible tool life, perfect chip control becomes a central issue in all modern production. These requirements are often difficult to fulfill with traditionally ground chip breakers because of insufficient chip break and removal.

In comparison to traditional grinding technologies, new manufacturing technologies have increased the degree of design free form tremendously, providing the ability to generate any three-dimensional shape. The new G-Line from multidec® has adopted the use of this new free form design technology, resulting in well thought-out chip breaking geometries that are fitted to the well-tried multidec®-CUT 3000 series of turning inserts, providing maximum performance.

Free form modeled chip breakers achieve significant improvements in a wide range of materials when compared to ground chip breakers. This advantage is particularly evident with difficult to machine materials such as super-alloys. In addition to significantly improved chip control, multidec®-G-Line inserts can achieve up to 30 % higher cutting values and up to 50 % longer tool life.



Advantages:

- improved chip control
- better cutting values
- longer tool life
- smaller chip volume
- better process reliability
- wear-resistant and tough carbide substrate with two heavy-duty coatings
- sharp and rounded cutting edges
- can be used on all multidec®-CUT 1600 and multidec®-CUT 3000 holders

Legend	4
--------	---

Application overview	6
----------------------	---

Use of the chip breakers	7
--------------------------	---



Success stories	8–9
-----------------	-----

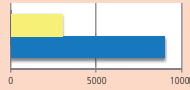

G-LINE inserts 1600	
1602... F. GT20	10
1602... F.V GT20	11
1602... F.N GT20	12
1603... F. GA20	13
1604... F. GB20	14
1604... F.V GB20	15
1605... F. GC20	16



G-LINE inserts 3000	
3002... F. GS12	17
3002... F.V GS12	18
3002... F.N GS12	19
3002... E. GT20	20
3002... E.V GT20	21
3002... E.N GT20	22
3003... E. GA20	23
3004... F... GB20	24
3004... F.V ... GB20	25
3005... F/E. GC20	26



G-LINE cutting specification	28
------------------------------	----

Material Group ISO 18185 (EN 1514)	Color	Compens. V (mm)	Feed Rate (mm/min)
Al-1000	Blue	0.05-0.10	100-200
Al-2000	Blue	0.05-0.10	100-200
Al-3000	Blue	0.05-0.10	100-200
Al-4000	Blue	0.05-0.10	100-200
Al-5000	Blue	0.05-0.10	100-200
Al-6000	Blue	0.05-0.10	100-200
Al-7000	Blue	0.05-0.10	100-200
Al-8000	Blue	0.05-0.10	100-200
Al-9000	Blue	0.05-0.10	100-200
Al-10000	Blue	0.05-0.10	100-200
Al-11000	Blue	0.05-0.10	100-200
Al-12000	Blue	0.05-0.10	100-200
Al-13000	Blue	0.05-0.10	100-200
Al-14000	Blue	0.05-0.10	100-200
Al-15000	Blue	0.05-0.10	100-200
Al-16000	Blue	0.05-0.10	100-200
Al-17000	Blue	0.05-0.10	100-200
Al-18000	Blue	0.05-0.10	100-200
Al-19000	Blue	0.05-0.10	100-200
Al-20000	Blue	0.05-0.10	100-200
Al-21000	Blue	0.05-0.10	100-200
Al-22000	Blue	0.05-0.10	100-200
Al-23000	Blue	0.05-0.10	100-200
Al-24000	Blue	0.05-0.10	100-200
Al-25000	Blue	0.05-0.10	100-200
Al-26000	Blue	0.05-0.10	100-200
Al-27000	Blue	0.05-0.10	100-200
Al-28000	Blue	0.05-0.10	100-200
Al-29000	Blue	0.05-0.10	100-200
Al-30000	Blue	0.05-0.10	100-200
Al-31000	Blue	0.05-0.10	100-200
Al-32000	Blue	0.05-0.10	100-200
Al-33000	Blue	0.05-0.10	100-200
Al-34000	Blue	0.05-0.10	100-200
Al-35000	Blue	0.05-0.10	100-200
Al-36000	Blue	0.05-0.10	100-200
Al-37000	Blue	0.05-0.10	100-200
Al-38000	Blue	0.05-0.10	100-200
Al-39000	Blue	0.05-0.10	100-200
Al-40000	Blue	0.05-0.10	100-200
Al-41000	Blue	0.05-0.10	100-200
Al-42000	Blue	0.05-0.10	100-200
Al-43000	Blue	0.05-0.10	100-200
Al-44000	Blue	0.05-0.10	100-200
Al-45000	Blue	0.05-0.10	100-200
Al-46000	Blue	0.05-0.10	100-200
Al-47000	Blue	0.05-0.10	100-200
Al-48000	Blue	0.05-0.10	100-200
Al-49000	Blue	0.05-0.10	100-200
Al-50000	Blue	0.05-0.10	100-200
Al-51000	Blue	0.05-0.10	100-200
Al-52000	Blue	0.05-0.10	100-200
Al-53000	Blue	0.05-0.10	100-200
Al-54000	Blue	0.05-0.10	100-200
Al-55000	Blue	0.05-0.10	100-200
Al-56000	Blue	0.05-0.10	100-200
Al-57000	Blue	0.05-0.10	100-200
Al-58000	Blue	0.05-0.10	100-200
Al-59000	Blue	0.05-0.10	100-200
Al-60000	Blue	0.05-0.10	100-200
Al-61000	Blue	0.05-0.10	100-200
Al-62000	Blue	0.05-0.10	100-200
Al-63000	Blue	0.05-0.10	100-200
Al-64000	Blue	0.05-0.10	100-200
Al-65000	Blue	0.05-0.10	100-200
Al-66000	Blue	0.05-0.10	100-200
Al-67000	Blue	0.05-0.10	100-200
Al-68000	Blue	0.05-0.10	100-200
Al-69000	Blue	0.05-0.10	100-200
Al-70000	Blue	0.05-0.10	100-200
Al-71000	Blue	0.05-0.10	100-200
Al-72000	Blue	0.05-0.10	100-200
Al-73000	Blue	0.05-0.10	100-200
Al-74000	Blue	0.05-0.10	100-200
Al-75000	Blue	0.05-0.10	100-200
Al-76000	Blue	0.05-0.10	100-200
Al-77000	Blue	0.05-0.10	100-200
Al-78000	Blue	0.05-0.10	100-200
Al-79000	Blue	0.05-0.10	100-200
Al-80000	Blue	0.05-0.10	100-200
Al-81000	Blue	0.05-0.10	100-200
Al-82000	Blue	0.05-0.10	100-200
Al-83000	Blue	0.05-0.10	100-200
Al-84000	Blue	0.05-0.10	100-200
Al-85000	Blue	0.05-0.10	100-200
Al-86000	Blue	0.05-0.10	100-200
Al-87000	Blue	0.05-0.10	100-200
Al-88000	Blue	0.05-0.10	100-200
Al-89000	Blue	0.05-0.10	100-200
Al-90000	Blue	0.05-0.10	100-200
Al-91000	Blue	0.05-0.10	100-200
Al-92000	Blue	0.05-0.10	100-200
Al-93000	Blue	0.05-0.10	100-200
Al-94000	Blue	0.05-0.10	100-200
Al-95000	Blue	0.05-0.10	100-200
Al-96000	Blue	0.05-0.10	100-200
Al-97000	Blue	0.05-0.10	100-200
Al-98000	Blue	0.05-0.10	100-200
Al-99000	Blue	0.05-0.10	100-200
Al-100000	Blue	0.05-0.10	100-200

Different information about multidec® application refer to certain machining methods. In addition, simple symbols inform of the product assortment and where additional products and technical information can be found.

Dimensions

All dimensions are in millimeter (mm); native dimensions in inch are calculated into millimeter.

Page information

□ 12... See page 12 and the following (example)

Recommended usage

- Preferred application
- Possible application
- Application not recommended

Availability

- Standard articles
- Standard articles, new in this catalogue
- Discontinued articles

Categorization of materials

The information on using multidec® tools refers to certain materials.

The materials to be machined are categorized in the same color throughout the entire catalog:

Steel (non-alloyed, low alloyed and high alloyed)
Stainless steel
Titanium and Ti-alloys
Non-ferrous metals (gold, aluminum and brass)
Hard materials

Order designation

To the designation of the selected type of product, the desired cutting material code must be added.

Supplementing information to the grades can be found according to the page references (□ ...).

Order designation		Carbide □ 20		
L	R	UHM 20	UHM 20 HPX	UHM 20 TX+
1605-0.5-1.5 L ...	1605-0.5-1.5 R ...	■	■	■
1605-1.0-2.5 L ...	1605-1.0-2.5 R ...	■	■	■
1605-1.5-3 L ...	1605-1.5-3 R ...	■	■	■

Example: 1605-0.5-1.5 L UHM 20

Packaging information

The product labels illustrate the content of the packaging and also show the materials on which the cutting insert can be used. For this purpose, UTILIS uses the ISO standard coding.

The UTILIS article number is generally also printed as a barcode on the UTILIS (multidec®) product packaging.

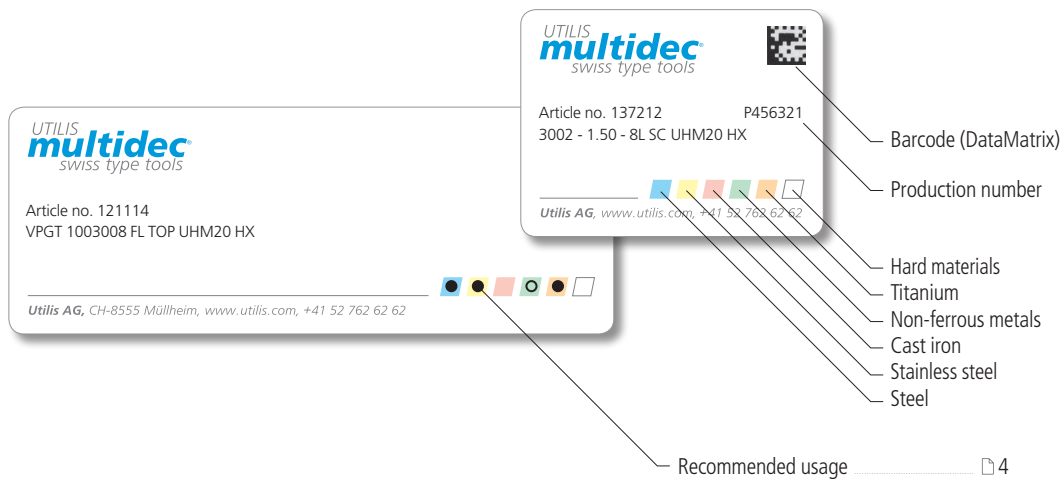

Execution of holder/insert

The side on which the insert is located determines whether it is a "left-" or "right-hand" holder. For this purpose, the holder is viewed with the insert pointing towards the observer.

Pictures

The right-hand version of the tools is usually shown. (Exceptions are possible). The tool colours illustrated here are not binding.

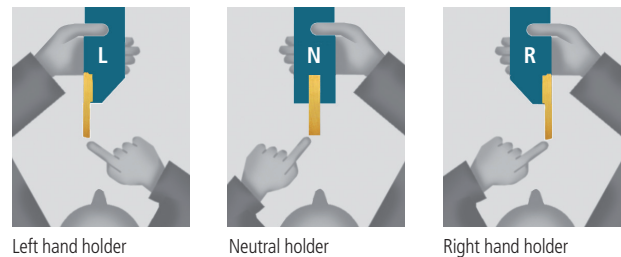

Product lines

To meet today's requirements of modern production it is not necessary to use the most accurate – but to use the tools adapted to the requirements. This means, the more accurate and sophisticated the process, the higher must be the accuracy of the produced tools. Therefore, the product range has been divided into three different accuracy classes. Your advantage: you buy the quality, which is effectively required.

Product line	Description
PREMIUM-LINE	The PREMIUM-LINE includes UTILIS tools with the highest accuracy requirements, especially for the production of micro parts. Tightest dimensional tolerances, precisely executed, highest surface quality and high repeatability are the features of this line. The manufacturing of these high-class tools requires considerable additional cost in production, which justifies the higher price of this product line.
STANDARD-LINE	The STANDARD-LINE meets the highest demands on the quality, which is demanded for Swiss type tools in production of small parts. Tight dimensional tolerances and high surface quality are implemented. These are quality standard tools, which are very well positioning this line in a wide range of applications.
VALUE-LINE	The VALUE-LINE is based on the known positions of our STANDARD-LINE. The most important functional elements – such as inserts and holders – are manufactured with the normal dimensional tolerances seen in the industry. Designed for the production of low-cost components, this line offers optimal quality standards. The greater tolerances and the reduced surface quality lower the production costs considerably, which also lowers the price in comparison to the standard product line.

multidec®-CUT 1600

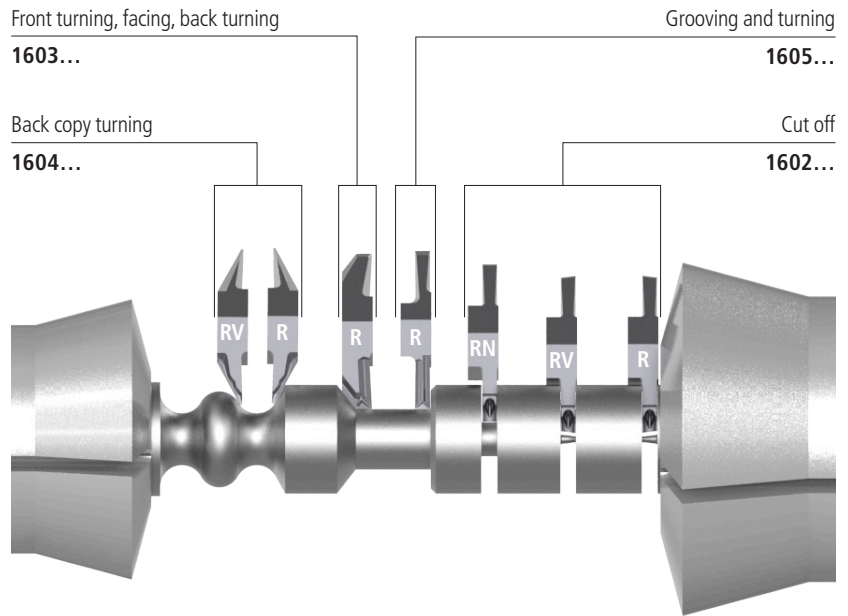

multidec®-CUT 3000

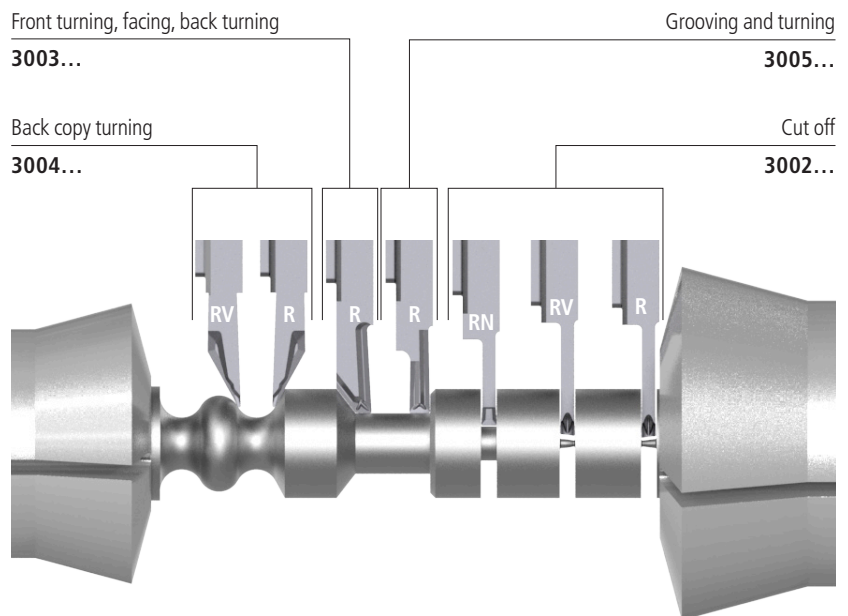

CUT 1600 & CUT 3000

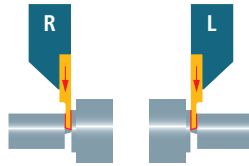
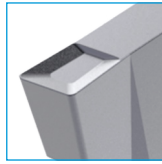

Cutting off with the GS12 chip breaker

The "GS12" geometry combines the advantages of the well-tried chip breaker of the "GS" product line with the accuracy of a ground parting-off insert. The sharp cutting edge provides excellent cutting ability. This makes it the number one choice in a wide range of applications in which a soft cut and good chip control are required, also with lower feed rates.

CUT 1600 & CUT 3000

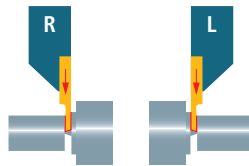
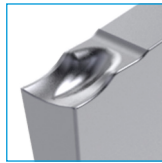

Cutting off with the GT20 chip breaker

The "GT20" geometry is another parting-off geometry which is available with a sharp and a slightly rounded cutting edge in comparison to the "GS12". The special design of this chip breaker guarantees excellent chip flow, short chips and generates smooth surfaces on the workpiece, even with higher feed rates.

CUT 1600 & CUT 3000

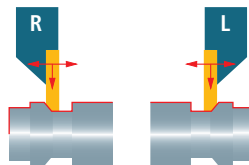
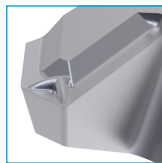

CUT 1600

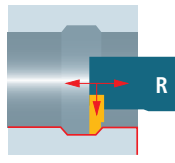

Front turning, facing and back turning with chip breaker GA20

With the "GA20" geometry, the proven chip breaker of the multidec®-TOP insert was taken as the basis and optimised. A circumferential chip breaker enables turning in three directions. Perfect chip control is guaranteed during facing, turning, grooving solid material and back turning. The cutting edge "TOP" also enables up to 100% higher feed.

CUT 1600 & CUT 3000

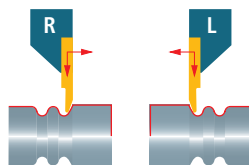

CUT 1600

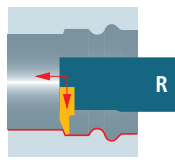

Copy turning (rear) with chip breaker GB20

The "GB20" geometry provides optimum and process-reliable chip formation with both low and higher cutting depths and feed rates with an extremely sharp cutting edge in combination with multi-stage chip breakers.

CUT 1600 & CUT 3000

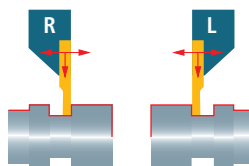
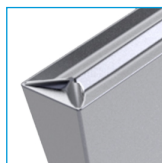

CUT 1600

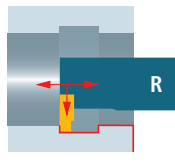

Grooving and turning with chip breaker GC20

The "GC20" geometry was tailored for facing, grooving and turning operations. Turning in three directions with extremely low and high cutting depths and feed rates requires a very sophisticated chip breaker in order to achieve optimum chip control.

This geometry provides a good solution in almost any material. This geometry even achieves excellent results in lead-free brass, a material with which chip control is difficult.

Operation grooving and turning with the "GC20" chip breaker

In a comparison between the new G-LINE "GC20" chip breaker and a ground chip breaker which has been established for a long time, perfect rolled chips and an extremely neat finish were achieved on the workpiece with consistent cutting data. The tool life was increased by 200 %, from 3000 to 9000 parts.

CHIP REMOVAL COMPARISON

Machine model	Star SR 10 type C
Material number	1.4435
Material specification	X2CrNiMo 18-14-3 (316 L)
Bar diameter (mm)	4
Operation	Grooving and turning
Cooling	Oil

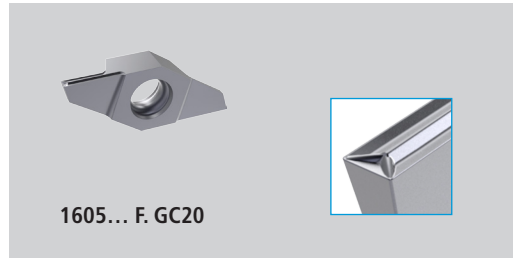

CURRENT

Insert designation	Ground grooving and turning insert	Brand	Competitor
--------------------	------------------------------------	-------	------------

Cutting speed (Vc)	75 m/min
Cutting depth (ap)	1.00 mm
Feed rate (f)	0.01 mm/rev
Number of workpieces	3000

UTILIS (multidec-CUT, G-LINE)

Insert designation	1605-1.0-1.5 FL GC20 R05 UHM20 HPX	Brand	UTILIS
--------------------	------------------------------------	-------	--------

Cutting speed (Vc)	75 m/min
Cutting depth (ap)	1.00 mm
Feed rate (f)	0.01 mm/rev
Number of workpieces	9000

SUMMARY

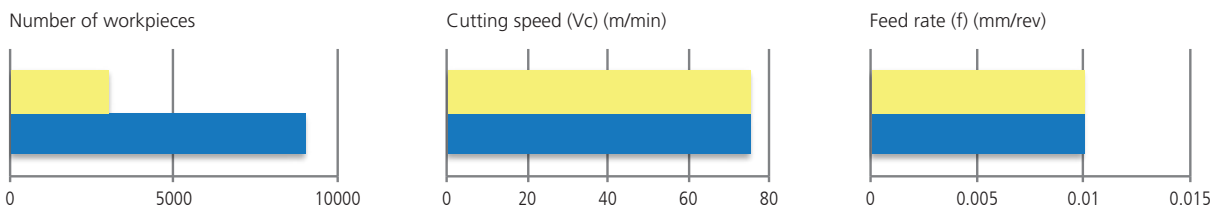

Operation cutting off with chip breaker "GS12"

Here a comparison was made between the "GS12" chip breaker and a competitor chip breaker which had already been successfully used in this material. Because of the better chip flow and short chips, it was possible to increase the tool life considerably with the new G-LINE insert with higher cutting values.

CHIP REMOVAL COMPARISON

Machine model	Citizen M 32
Material number	1.4104
Material specification	X12CrMoS17 (SUS430F)
Bar diameter (mm)	16
Operation	CUT off
Cooling	Oil



CURRENT

Insert designation	Sintered CUT off insert	Brand	Competitor
--------------------	-------------------------	-------	------------

Cutting speed (Vc)	85 m/min
Cutting depth (ap)	8.00 mm
Feed rate (f)	0.03 mm/rev
Number of workpieces	310

UTILIS (multidec-CUT, G-LINE)

Insert designation	3002-2-10 FLN GS12 UHM20 TX+	Brand	UTILIS
--------------------	------------------------------	-------	--------

Cutting speed (Vc)	120 m/min
Cutting depth (ap)	8.00 mm
Feed rate (f)	0.05 mm/rev
Number of workpieces	480

SUMMARY

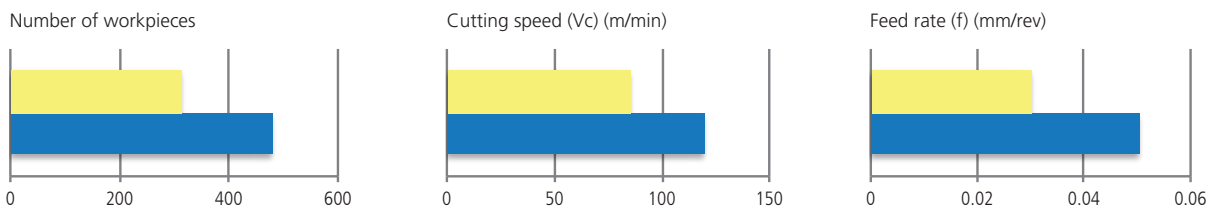

10

UTILIS
multidec[®]
swiss type tools



CUT off
"GT20" chip breaker

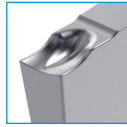
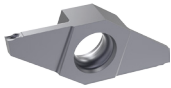

F: Insert with sharp cutting edge

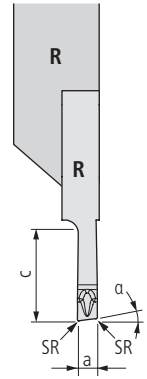
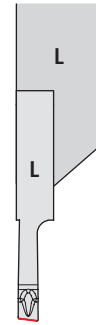

1602... F. GT20

Order designation		Carbide **						Dimensions				Holder **	
		-	-	●	○	●	●						
		-	●	●	○	●	●						
		○	○	-	○	○	○						
		●	○	-	●	○	-						
		-	-	●	-	-	-						
L	R	UHM 10	UHM 10HX	UHM 10TX+	UHM 20	UHM 20HPX	UHM 20TX+	a	c	α	SR*		
PREMIUM-LINE													
1602-0.8-5 FL GT20 ...	1602-0.8-5 FR GT20 ...			■	■	■		0.8	5	7°	0.05		1600...
1602-1.0-5 FL GT20 ...	1602-1.0-5 FR GT20 ...			■	■	■		1	5	7°	0.05		1600...
1602-1.5-5 FL GT20 ...	1602-1.5-5 FR GT20 ...			■	■	■		1.5	5	7°	0.05		1600...

* SR: Protection radius

G-LINE cutting specification 28



CUT off (offset)
"GT20" chip breaker



1602... F.V GT20



F: Insert with sharp cutting edge

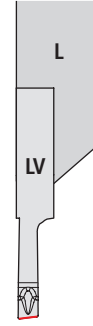

V: offset

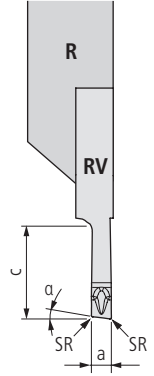

Order designation	Carbide **						Dimensions				Holders **
	-	-	●	○	●	●	a	c	α	SR*	
<div style="display: flex; justify-content: space-around;"> <div style="text-align: center;"> L </div> <div style="text-align: center;"> R </div> </div>	-	-	●	○	●	●					
	○	●	●	○	○	●					
	●	○	-	○	○	-					
	-	-	●	-	-	-					
	UHM 10	UHM 10HX	UHM 10TX+	UHM 20	UHM 20HPX	UHM 20TX+					

PREMIUM-LINE

1602-0.8-5 FLV GT20 ...	1602-0.8-5 FRV GT20 ...			■	■	■	0.8	5	7°	0.05		1600...
1602-1.0-5 FLV GT20 ...	1602-1.0-5 FRV GT20 ...			■	■	■	1	5	7°	0.05		1600...
1602-1.5-5 FLV GT20 ...	1602-1.5-5 FRV GT20 ...			■	■	■	1.5	5	7°	0.05		1600...

* SR: Protection radius

G-LINE cutting specification 28



Item 300362

** Can be found in general catalogue 2022 / 23

- Technical information 9-29
- Holder multidec®-CUT 1600 90-104

www.utilis.com



Legend 4...

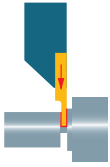

CUT off (neutral)
"GT20" chip breaker

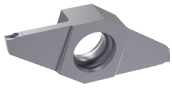

1602... F.N GT20

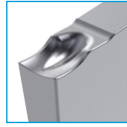

F: Insert with sharp cutting edge

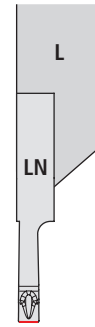

N: neutral

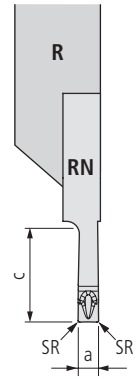

Order designation		Carbide **						Dimensions				Holders **
		-	-	●	○	●	●	a	c	SR*		
L	R	-	-	●	○	●	●					
		○	●	●	○	●	●					
		●	○	-	●	○	-					
		-	-	●	-	-	-					
		UHM 10	UHM 10HX	UHM 10TX+	UHM 20	UHM 20HPX	UHM 20TX+					
PREMIUM-LINE												
1602-0.8-5 FLN GT20 ...	1602-0.8-5 FRN GT20 ...			■	■	■	0.8	5		0.05		1600...
1602-1.0-5 FLN GT20 ...	1602-1.0-5 FRN GT20 ...			■	■	■	1	5		0.05		1600...
1602-1.5-5 FLN GT20 ...	1602-1.5-5 FRN GT20 ...			■	■	■	1.5	5		0.05		1600...

* SR: Protection radius

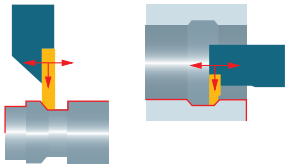

Front turning, facing, back turning
chip breaker "GA20"

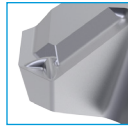

F: Insert with sharp cutting edge

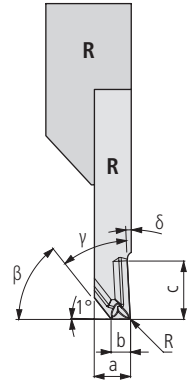
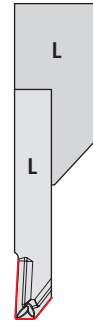

1603... F. GA20

Order designation		Carbide **						Dimensions							Holder **
		-	-	●	○	●	●								
		○	●	●	○	○	●								
		●	○	-	○	○	○								
		-	-	●	-	-	-								
L	R	UHM 10	UHM 10HX	UHM 10TX+	UHM 20	UHM 20HPX	UHM 20TX+	a	b	c	β	γ	δ	R	

PREMIUM-LINE

1603-3.0-5 FL GA20 TOP ZZ ...	1603-3.0-5 FR GA20 TOP ZZ ...				■	■	■	3	1.6	5	52°	35°	3°	-	1600...
1603-3.0-5 FL GA20 TOP R03...	1603-3.0-5 FR GA20 TOP R03...				■	■	■	3	1.6	5	52°	35°	3°	0.03	1600...
1603-3.0-5 FL GA20 TOP R05...	1603-3.0-5 FR GA20 TOP R05...				■	■	■	3	1.6	5	52°	35°	3°	0.05	1600...
1603-3.0-5 FL GA20 TOP R15...	1603-3.0-5 FR GA20 TOP R15...				■	■	■	3	1.6	5	52°	35°	3°	0.15	1600...

G-LINE cutting specification 28



Item 300362

** Can be found in general catalogue 2022/23

- Technical information 9-29
- Holder multidec®-CUT 1600 90-104

www.utilis.com



Legend 4...

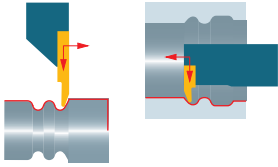

Copy turning (back)
chip breaker "GB20"

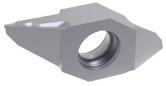

1604... F. GB20



F: Insert with sharp cutting edge

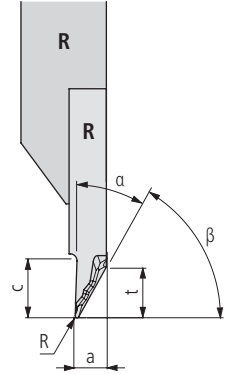
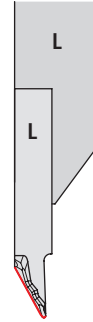

Order designation		Carbide *						Dimensions						Holders *
		-	-	●	○	●	●							
		-	●	●	○	●	●							
		○	○	-	○	○	○							
		●	○	-	●	○	-							
		-	-	●	-	-	-							
L	R	UHM 10	UHM 10HX	UHM 10TX+	UHM 20	UHM 20HPX	UHM 20TX+	a	c	α	β	R	t	

PREMIUM-LINE

1604-2.5-4-5 FL 29005 GB20 ...	1604-2.5-4-5 FR 29005 GB20 ...				■	■	■	2.5	4.5	27°	61°	0.05	4	1600...
1604-2.5-4-5 FL 29015 GB20 ...	1604-2.5-4-5 FR 29015 GB20 ...				■	■	■	2.5	4.5	27°	61°	0.15	4	1600...

G-LINE cutting specification 28

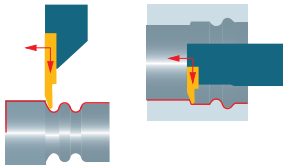

Copy turning (back, offset) chip breaker "GB20"

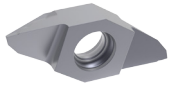

1604... F.V GB20

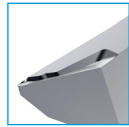

F: Insert with sharp cutting edge

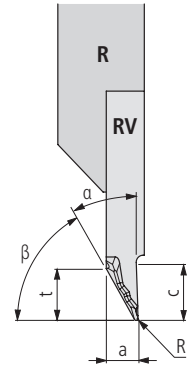
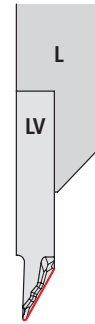

UTILIS
multidec
swiss type tools

Order designation		Carbide *						Dimensions						Holder *
		-	-	●	○	●	●							
		○	●	●	○	○	●							
		●	○	-	-	○	○							
		-	-	●	-	-	-							
L	R	UHM 10	UHM 10HX	UHM 10TX+	UHM 20	UHM 20HPX	UHM 20TX+	a	c	α	β	R	t	

PREMIUM-LINE

1604-2.5-4-5 FLV 29005 GB20 ...	1604-2.5-4-5 FRV 29005 GB20 ...				■	■	■	2.5	4.5	27°	61°	0.05	4	1600...
1604-2.5-4-5 FLV 29015 GB20 ...	1604-2.5-4-5 FRV 29015 GB20 ...				■	■	■	2.5	4.5	27°	61°	0.15	4	1600...

G-LINE cutting specification 28



Item 300362

* Can be found in general catalogue 2022/23

- Technical information 9-29
- Holder multidec®-CUT 1600 90-104

www.utilis.com

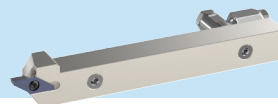

Legend 4...

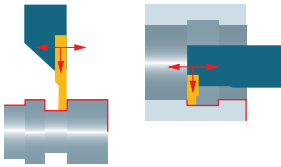

Grooving and turning
"GC20" chip breaker

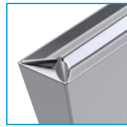
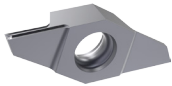

F: Insert with sharp cutting edge

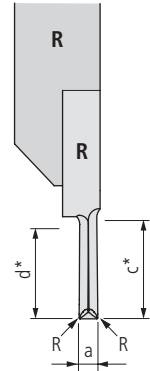
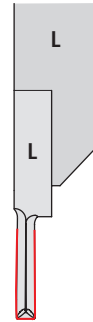

1605... F. GC20

Order designation	Carbide **						Dimensions				Holders **	
	-	-	●	○	●	●	a	C*	d*	R		
<div style="display: flex; justify-content: space-around;"> <div style="text-align: center;"> <p>L</p> </div> <div style="text-align: center;"> <p>R</p> </div> </div>	-	-	●	○	●	●						
	-	-	●	○	●	●						
	○	○	●	○	○	○						
	●	○	-	●	○	○						
	-	-	●	-	-	-						
		UHM 10	UHM 10HX	UHM 10TX+	UHM 20	UHM 20HPX	UHM 20TX+					

PREMIUM-LINE

1605-0.8-1.5 FL GC20 ZZ ...	1605-0.8-1.5 FR GC20 ZZ ...			■	■	■	0.8	1.5	1.5	-		1600...
1605-0.8-1.5 FL GC20 R02 ...	1605-0.8-1.5 FR GC20 R02 ...			■	■	■	0.8	1.5	1.5	0.02		1600...
1605-0.8-1.5 FL GC20 R05 ...	1605-0.8-1.5 FR GC20 R05 ...			■	■	■	0.8	1.5	1.5	0.05		1600...
1605-1.0-1.5 FL GC20 ZZ ...	1605-1.0-1.5 FR GC20 ZZ ...			■	■	■	1	1.5	1.5	-		1600...
1605-1.0-1.5 FL GC20 R02 ...	1605-1.0-1.5 FR GC20 R02 ...			■	■	■	1	1.5	1.5	0.02		1600...
1605-1.0-1.5 FL GC20 R05 ...	1605-1.0-1.5 FR GC20 R05 ...			■	■	■	1	1.5	1.5	0.05		1600...
1605-1.0-3.5 FL GC20 ZZ ...	1605-1.0-3.5 FR GC20 ZZ ...			■	■	■	1	5	3.5	-		1600...
1605-1.0-3.5 FL GC20 R05 ...	1605-1.0-3.5 FR GC20 R05 ...			■	■	■	1	5	3.5	0.05		1600...
1605-1.5-4.5 FL GC20 R05 ...	1605-1.5-4.5 FR GC20 R05 ...			■	■	■	1.5	5	4.5	0.05		1600...
1605-2.0-5 FL GC20 R05 ...	1605-2.0-5 FR GC20 R05 ...			■	■	■	2	5	5	0.05		1600...
1605-2.0-5 FL GC20 R15 ...	1605-2.0-5 FR GC20 R15 ...			■	■	■	2	5	5	0.15		1600...

* c: maximal turning capacity
d: maximal grooving capacity

G-LINE cutting specification 28



Item 300362

** Can be found in general catalogue 2022 / 23
 - Technical information 9-29
 - Holder multidec®-CUT 1600 90-104

www.utilis.com

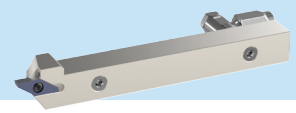

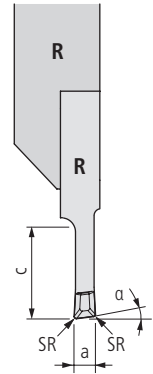
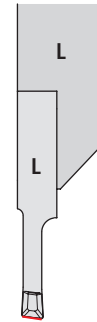
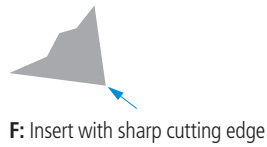
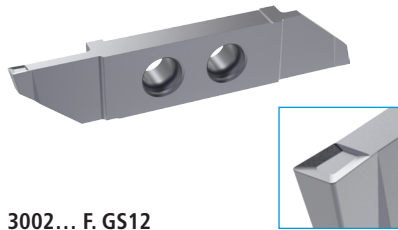

3002... F. GS12

Order designation	Carbide **						Dimensions				Holders **
	-	-	●	○	●	●	a	c	α	SR*	
<div style="display: flex; justify-content: space-around;"> <div style="text-align: center;"> L </div> <div style="text-align: center;"> R </div> </div>	-	-	●	○	●	●					
	○	●	●	○	●	●					
	●	○	-	○	○	-					
	-	-	●	-	-	-					
		UHM 10	UHM 10HX	UHM 10TX+	UHM 20	UHM 20HPX					
						UHM 20TX+					

PREMIUM-LINE

3002-1.5-10 FL GS12 ...	3002-1.5-10 FR GS12 ...				■	■	1.5	10	7°	0.15		3000...
3002-1.5-16 FL GS12 ...	3002-1.5-16 FR GS12 ...				■	■	1.5	16	7°	0.15		3000...
3002-2.0-10 FL GS12 ...	3002-2.0-10 FR GS12 ...				■	■	2	10	7°	0.2		3000...
3002-2.0-16 FL GS12 ...	3002-2.0-16 FR GS12 ...				■	■	2	16	7°	0.2		3000...
3002-2.5-13 FL GS12 ...	3002-2.5-13 FR GS12 ...				■	■	2.5	13	7°	0.2		3000...
3002-2.5-16 FL GS12 ...	3002-2.5-16 FR GS12 ...				■	■	2.5	16	7°	0.2		3000...
3002-3.0-16 FL GS12 ...	3002-3.0-16 FR GS12 ...				■	■	3	16	7°	0.2		3000...

* SR: Protection radius

G-LINE cutting specification 28



Item 300362

** Can be found in general catalogue 2022/23

- Technical information 9-29
- Holder multidec®-CUT 3000 172-180

www.utilis.com

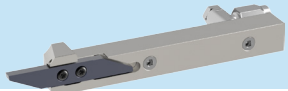

Legend 4...



CUT off (offset)
"GS12" chip breaker

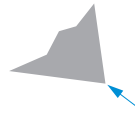

F: Insert with sharp cutting edge

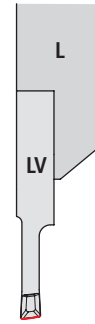

V: offset

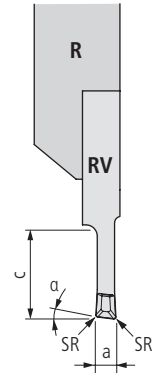

3002... F.V GS12

Order designation	Carbide **						Dimensions				Holders **
	-	-	●	○	●	●	a	c	α	SR*	
<div style="display: flex; justify-content: space-around;"> <div style="text-align: center;"> L </div> <div style="text-align: center;"> R </div> </div>	-	-	●	○	●	●					
	○	-	●	○	○	●					
	●	○	-	●	○	-					
	-	-	●	-	-	-					

PREMIUM-LINE

3002-1.5-10 FLV GS12 ...	3002-1.5-10 FRV GS12 ...				■	■	1.5	10	7°	0.15		3000...
3002-1.5-16 FLV GS12 ...	3002-1.5-16 FRV GS12 ...				■	■	1.5	16	7°	0.15		3000...
3002-2.0-10 FLV GS12 ...	3002-2.0-10 FRV GS12 ...				■	■	2	10	7°	0.2		3000...
3002-2.0-16 FLV GS12 ...	3002-2.0-16 FRV GS12 ...				■	■	2	16	7°	0.2		3000...
3002-2.5-13 FLV GS12 ...	3002-2.5-13 FRV GS12 ...				■	■	2.5	13	7°	0.2		3000...
3002-2.5-16 FLV GS12 ...	3002-2.5-16 FRV GS12 ...				■	■	2.5	16	7°	0.2		3000...
3002-3.0-16 FLV GS12 ...	3002-3.0-16 FRV GS12 ...				■	■	3	16	7°	0.2		3000...

* SR: Protection radius

G-LINE cutting specification 28



CUT off (neutral)
"GS12" chip breaker



F: Insert with sharp cutting edge

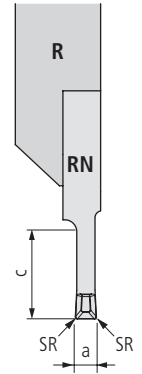

N: neutral

3002... F.N GS12

Order designation	Carbide **						Dimensions				Holders **
	-	-	●	○	●	●	a	c		SR*	
<div style="display: flex; justify-content: space-around;"> <div style="text-align: center;">L</div> <div style="text-align: center;">R</div> </div>	UHM 10	UHM 10HX	UHM 10TX+	UHM 20	UHM 20HPX	UHM 20TX+					
	○	○	○	○	○	○					
	●	●	●	●	●	●					
	○	○	○	○	○	○					
	●	●	●	●	●	●					
	○	○	○	○	○	○					

PREMIUM-LINE

3002-0.8-10 FLN GS12 ...	3002-0.8-10 FRN GS12 ...					■	■	0.8	10		0.05		3000...
3002-1.0-10 FLN GS12 ...	3002-1.0-10 FRN GS12 ...					■	■	1	10		0.05		3000...
3002-1.0-16 FLN GS12 ...	3002-1.0-16 FRN GS12 ...					■	■	1	16		0.05		3000...
3002-1.5-10 FLN GS12 ...	3002-1.5-10 FRN GS12 ...					■	■	1.5	10		0.15		3000...
3002-1.5-16 FLN GS12 ...	3002-1.5-16 FRN GS12 ...					■	■	1.5	16		0.15		3000...
3002-2.0-10 FLN GS12 ...	3002-2.0-10 FRN GS12 ...					■	■	2	10		0.2		3000...
3002-2.0-16 FLN GS12 ...	3002-2.0-16 FRN GS12 ...					■	■	2	16		0.2		3000...
3002-2.5-13 FLN GS12 ...	3002-2.5-13 FRN GS12 ...					■	■	2.5	13		0.2		3000...
3002-2.5-16 FLN GS12 ...	3002-2.5-16 FRN GS12 ...					■	■	2.5	16		0.2		3000...
3002-3.0-16 FLN GS12 ...	3002-3.0-16 FRN GS12 ...					■	■	3	16		0.2		3000...

* SR: Protection radius

G-LINE cutting specification 28



Item 300362

** Can be found in general catalogue 2022/23

- Technical information 9-29
- Holder multidec®-CUT 3000 172-180

www.utilis.com

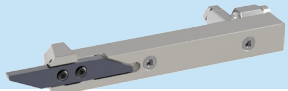

Legend 4...



CUT off
"GT20" chip breaker



3002... E. GT20

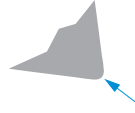

E: Insert with rounded cutting edge

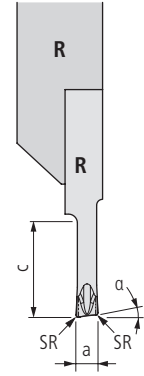

Order designation	Carbide **						Dimensions				Holders **
	-	-	●	○	●	●	a	c	α	SR*	
<div style="display: flex; justify-content: space-around;"> <div style="border: 1px solid black; padding: 2px;">L</div> <div style="border: 1px solid black; padding: 2px;">R</div> </div>	-	-	●	○	●	●					
	-	●	●	○	●	●					
	○	○	-	○	○	-					
	●	○	-	-	○	-					
	-	-	●	-	-	-					
	UHM 10	UHM 10HX	UHM 10TX+	UHM 20	UHM 20HPX	UHM 20TX+					

PREMIUM-LINE

3002-1.5-10 EL GT20 ...	3002-1.5-10 ER GT20 ...				■	■	■	1.5	10	7°	0.15		3000...
3002-2.0-16 EL GT20 ...	3002-2.0-16 ER GT20 ...				■	■	■	2	16	7°	0.2		3000...

* SR: Protection radius



CUT off (offset)
"GT20" chip breaker

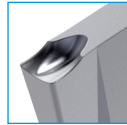

E: Insert with rounded cutting edge

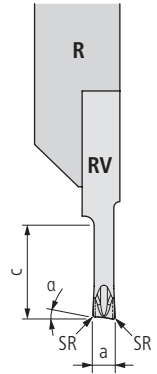

V: offset

3002... E.V GT20

Order designation	Carbide **						Dimensions				Holders **	
	-	-	●	○	●	●	a	c	α	SR*		
<div style="display: flex; justify-content: space-around;"> <div style="text-align: center;"> L </div> <div style="text-align: center;"> R </div> </div>	○	○	●	○	●	●						
	○	○	●	○	●	●						
	●	○	-	-	○	-						
	-	-	●	-	-	-						
	UHM 10	UHM 10HX	UHM 10TX+	UHM 20	UHM 20HPX	UHM 20TX+						

PREMIUM-LINE

3002-1.5-10 ELV GT20 ...	3002-1.5-10 ERV GT20 ...				■	■	■	1.5	10	7°	0.15		3000...
3002-2.0-16 ELV GT20 ...	3002-2.0-16 ERV GT20 ...				■	■	■	2	16	7°	0.2		3000...

* SR: Protection radius

G-LINE cutting specification 28



Item 300362

** Can be found in general catalogue 2022/23

- Technical information 9-29
- Holder multidec®-CUT 3000 172-180

www.utilis.com

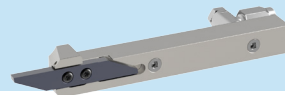

Legend 4...

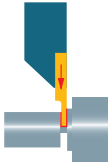

CUT off (neutral)
"GT20" chip breaker



3002... E.N GT20

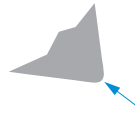

E: Insert with rounded cutting edge



N: neutral

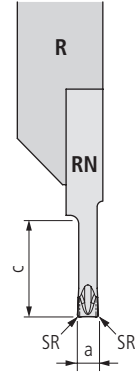

Order designation	Carbide **						Dimensions				Holders **
	-	-	●	○	●	●	a	c	SR*		
<div style="display: flex; justify-content: space-around;"> <div style="text-align: center;"> <p>L</p> </div> <div style="text-align: center;"> <p>R</p> </div> </div>	-	-	●	○	●	●					
	○	●	●	○	●	●					
	●	○	-	●	○	-					
	-	-	●	-	-	-					
	UHM 10	UHM 10HX	UHM 10TX+	UHM 20	UHM 20HPX	UHM 20TX+					

PREMIUM-LINE

3002-1.0-10 ELN GT20 ...	3002-1.0-10 ERN GT20 ...			■	■	■	1	10		0.05		3000...
3002-1.0-16 ELN GT20 ...	3002-1.0-16 ERN GT20 ...			■	■	■	1	16		0.05		3000...
3002-1.5-10 ELN GT20 ...	3002-1.5-10 ERN GT20 ...			■	■	■	1.5	10		0.15		3000...
3002-2.0-16 ELN GT20 ...	3002-2.0-16 ERN GT20 ...			■	■	■	2	16		0.2		3000...

* SR: Protection radius

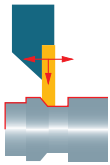

Front turning, facing, back turning
chip breaker "GA20"

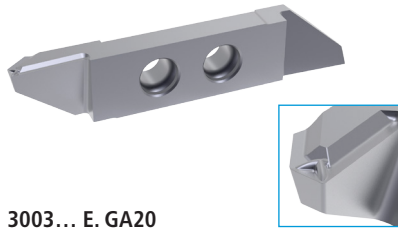

E: Insert with rounded cutting edge

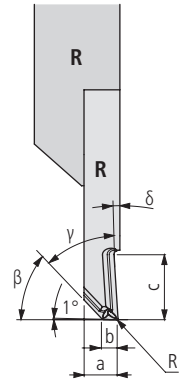
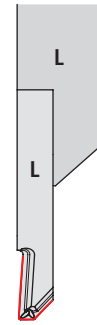

3003... E. GA20

Order designation	Carbide **						Dimensions							Holders **	
	-	-	●	○	●	●	a	b	c	β	γ	δ	R		
<div style="display: flex; justify-content: space-around;"> <div style="text-align: center;">L</div> <div style="text-align: center;">R</div> </div>	-	-	●	○	●	●									
	○	●	●	○	●	●									
	●	○	-	○	○	-									
	-	-	●	-	-	-									
							UHM 10	UHM 10HX	UHM 10TX+	UHM 20	UHM 20HPX	UHM 20TX+			

PREMIUM-LINE

3003-3.4-8 EL GA20 TOP ZZ ...	3003-3.4-8 ER GA20 TOP ZZ ...				■	■	■	3.4	1.6	8	52°	35°	3°	-	3000...
3003-3.4-8 EL GA20 TOP R08 ...	3003-3.4-8 ER GA20 TOP R08 ...				■	■	■	3.4	1.6	8	52°	35°	3°	0.08	3000...
3003-3.4-8 EL GA20 TOP R15 ...	3003-3.4-8 ER GA20 TOP R15 ...				■	■	■	3.4	1.6	8	52°	35°	3°	0.15	3000...

G-LINE cutting specification 28



Item 300362

** Can be found in general catalogue 2022/23

- Technical information 9-29
- Holder multidec®-CUT 3000 172-180

www.utilis.com

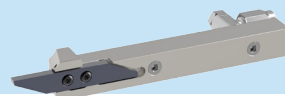

Legend 4...

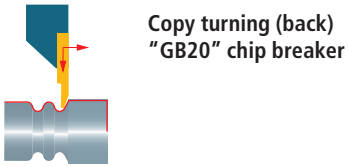

3004... F... GB20

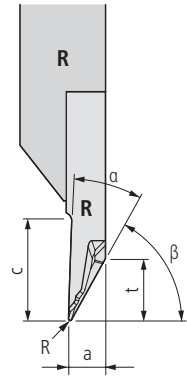
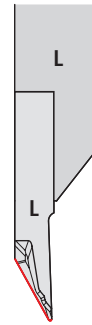
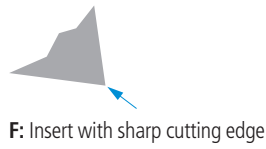

Order designation	Carbide *						Dimensions						Holders *
	-	-	●	○	●	●	a	c	α	β	R	t	
<div style="display: flex; justify-content: space-around;"> <div style="text-align: center;">L</div> <div style="text-align: center;">R</div> </div>	-	-	●	○	●	●							
	○	○	●	○	●	●							
	●	○	-	●	○	-							
	-	-	●	-	-	-							
	UHM 10	UHM 10HX	UHM 10TX+	UHM 20	UHM 20HPX	UHM 20TX+	a	c	α	β	R	t	

PREMIUM-LINE

3004-3.2-6 FL 29008 GB20 ...	3004-3.2-6 FR 29008 GB20 ...				■	■	■	3.2	11	29°	59°	0.08	5.5	3000...
3004-3.2-6 FL 29015 GB20 ...	3004-3.2-6 FR 29015 GB20 ...				■	■	■	3.2	11	29°	59°	0.15	5.3	3000...
3004-3.2-6 FL 29035 GB20 ...	3004-3.2-6 FR 29035 GB20 ...				■	■	■	3.2	11	29°	59°	0.35	4.7	3000...

G-LINE cutting specification 28

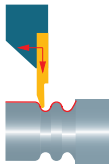

Copy turning (back, offset)
"GB20" chip breaker



F: Insert with sharp cutting edge



V: offset

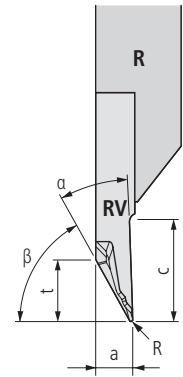

3004... F.V ... GB20

Order designation	Carbide *						Dimensions						Holders *
	-	-	●	○	●	●	a	c	α	β	R	t	
<div style="display: flex; justify-content: space-around;"> <div style="text-align: center;"> L </div> <div style="text-align: center;"> R </div> </div>	-	-	●	○	●	●							
	○	●	●	○	●	●							
	●	○	-	○	○	-							
	-	-	●	-	-	-							

PREMIUM-LINE

3004-3.2-6 FLV 29008 GB20 ...	3004-3.2-6 FRV 29008 GB20 ...				■	■	■	3.2	11	29°	59°	0.08	5.5	3000...
3004-3.2-6 FLV 29015 GB20 ...	3004-3.2-6 FRV 29015 GB20 ...				■	■	■	3.2	11	29°	59°	0.15	5.3	3000...
3004-3.2-6 FLV 29035 GB20 ...	3004-3.2-6 FRV 29035 GB20 ...				■	■	■	3.2	11	29°	59°	0.35	4.7	3000...

G-LINE cutting specification 28



Item 300362

* Can be found in general catalogue 2022/23

- Technical information 9-29
- Holder multidec®-CUT 3000 172-180

www.utilis.com

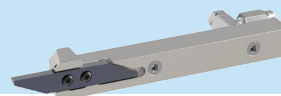

Legend 4...

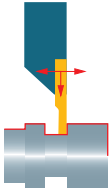

Grooving and turning
"GC20" chip breaker



3005... F./E. GC20

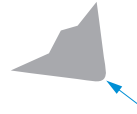

E: Insert with rounded cutting edge



F: Insert with sharp cutting edge

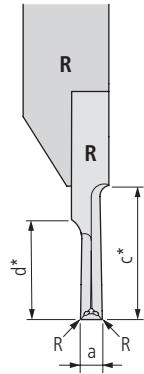
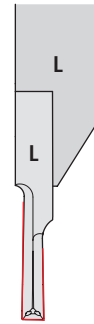

Order designation	Carbide **						Dimensions				Holders **
	-	-	●	○	●	●	a	c*	d*	R	
L	-	-	●	○	●	●					
R	-	○	●	○	●	●					
	-	○	-	●	○	-					
	-	-	●	-	-	-					
	UHM 10	UHM 10HX	UHM 10TX+	UHM 20	UHM 20HPX	UHM 20TX+	a	c*	d*	R	

PREMIUM-LINE

3005-1.0-8 FL GC20 ZZ ...	3005-1.0-8 FR GC20 ZZ ...			■	■	■	1	8	3.5	-	3000...
3005-1.0-8 FL GC20 R02 ...	3005-1.0-8 FR GC20 R02 ...			■	■	■	1	8	3.5	0.02	3000...
3005-1.0-8 FL GC20 R05 ...	3005-1.0-8 FR GC20 R05 ...			■	■	■	1	8	3.5	0.05	3000...
3005-1.5-8 FL GC20 ZZ ...	3005-1.5-8 FR GC20 ZZ ...			■	■	■	1.5	8	4	-	3000...
3005-1.5-8 FL GC20 R02 ...	3005-1.5-8 FR GC20 R02 ...			■	■	■	1.5	8	4	0.02	3000...
3005-1.5-8 FL GC20 R05 ...	3005-1.5-8 FR GC20 R05 ...			■	■	■	1.5	8	4	0.05	3000...
3005-2.0-8 EL GC20 R05 ...	3005-2.0-8 ER GC20 R05 ...			■	■	■	2	8	5	0.05	3000...
3005-2.0-8 EL GC20 R15 ...	3005-2.0-8 ER GC20 R15 ...			■	■	■	2	8	5	0.15	3000...
3005-3.0-8 EL GC20 R15 ...	3005-3.0-8 ER GC20 R15 ...			■	■	■	3	8	6	0.15	3000...
3005-3.0-8 EL GC20 R35 ...	3005-3.0-8 ER GC20 R35 ...			■	■	■	3	8	6	0.35	3000...

* c: maximal turning capacity
d: maximal grooving capacity

G-LINE cutting specification 28



Item 300362

** Can be found in general catalogue 2022/23

- Technical information 9-29
- Holder multidec®-CUT 3000 172-180

www.utilis.com

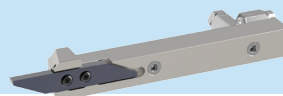

CUT off*

Materials (category) Hardness value (HB)/(HRC)	Carbide	Cutting speeds v_c (m/min)			Feeds f (mm/rev)		
		▼			▼		
Steel non-alloyed (I) 125–300 HB	UHM 20	40–120			0.03–0.1		
	UHM 20 HPX	60–160			0.03–0.1		
	UHM 20 TX+	60–180			0.03–0.1		
Steel low alloyed (II) 180–250 HB	UHM 20	40–110			0.03–0.1		
	UHM 20 HPX	60–170			0.03–0.1		
	UHM 20 TX+	60–160			0.03–0.1		
Steel high alloyed (III) 200–350 HB	UHM 20	40–110			0.01–0.1		
	UHM 20 HPX	60–150			0.01–0.1		
	UHM 20 TX+	60–140			0.01–0.1		
Stainless steel (V) 180–220 HB	UHM 20	40–100			0.01–0.1		
	UHM 20 HPX	80–150			0.01–0.1		
	UHM 20 TX+	70–140			0.01–0.1		
Stainless steel (VI) 220–330 HB	UHM 20	30–70			0.005–0.03		
	UHM 20 HPX	70–90			0.005–0.03		
	UHM 20 TX+	60–80			0.005–0.03		
Titanium (IV) –	UHM 20	40–60			0.01–0.07		
	UHM 20 HPX	50–80			0.02–0.07		
	UHM 20 TX+	50–70			0.02–0.08		
Aluminum (VII) 60–130 HB	UHM 20	100–1500			0.08–0.3		
	UHM 20 HPX	110–1650			0.1–0.3		
	UHM 20 TX+	–			0.1–0.3		
Brass / lead-free brass (VIII) –	UHM 20	80–200			0.08–0.3		
	UHM 20 HPX	88–220			0.1–0.3		
	UHM 20 TX+	90–200			0.1–0.3		
Synthetics reinforced/composites (IX) –	UHM 20	–			–		
	UHM 20 HPX	–			–		
	UHM 20 TX+	–			–		
Hard materials (X) 45–70 HRC	UHM 20	–			–		
	UHM 20 HPX	–			–		
	UHM 20 TX+	–			–		

* Reduce the feed rate by 30 % when feeding in until the insert fully engages and when moving out the final 0.3 mm.

Note

- In order to achieve good results, oil cooling is recommended, preferably at high pressure, with approx. 60 bar. Too much pressure can have a negative influence on chip formation.
- With stable conditions, the use of holders with integrated cooling "IC" and optimum cooling can generally increase the cutting data by up to 30 %.

Grooving and Turning / copy turning*

Materials (category) Hardness value (HB) / (HRC)	Carbide	Cutting speeds v_c (m/min)			Feeds f (mm/rev)			Depths of cut a_p (mm)		
		▼	▼▼	▼▼▼	▼	▼▼	▼▼▼	▼	▼▼	▼▼▼
Steel non-alloyed (I) 125–300 HB	UHM 20	40–110	60–120	60–140	0.03–0.1	0.03–0.15	0.01–0.15	0.5–4	0.1–2.5	0.05–1.5
	UHM 20 HPX	150–200	180–220	180–220	0.03–0.1	0.03–0.15	0.01–0.15	0.5–4	0.1–2.5	0.05–1.5
	UHM 20 TX+	130–170	160–194	170–210	0.03–0.1	0.03–0.15	0.01–0.15	0.5–4	0.1–2.5	0.05–1.5
Steel low alloyed (II) 180–250 HB	UHM 20	50–110	50–120	44–132	0.03–0.1	0.03–0.15	0.01–0.15	0.5–4	0.1–2.5	0.05–1.5
	UHM 20 HPX	90–170	90–180	176–220	0.03–0.1	0.03–0.15	0.01–0.15	0.5–4	0.1–2.5	0.05–1.5
	UHM 20 TX+	80–150	80–160	176–198	0.03–0.1	0.03–0.15	0.01–0.15	0.5–4	0.1–2.5	0.05–1.5
Steel high alloyed (III) 200–350 HB	UHM 20	40–80	40–80	40–100	0.03–0.1	0.03–0.15	0.01–0.15	0.5–4	0.1–2.5	0.05–1.5
	UHM 20 HPX	60–150	60–160	80–160	0.03–0.1	0.03–0.15	0.01–0.15	0.5–4	0.1–2.5	0.05–1.5
	UHM 20 TX+	60–140	60–150	70–150	0.03–0.1	0.03–0.15	0.01–0.15	0.5–4	0.1–2.5	0.05–1.5
Stainless steel (V) 180–220 HB	UHM 20	40–100	40–110	40–120	0.03–0.1	0.03–0.15	0.01–0.15	0.5–4	0.1–2.5	0.05–1.5
	UHM 20 HPX	80–150	100–180	120–200	0.03–0.1	0.03–0.15	0.01–0.15	0.5–4	0.1–2.5	0.05–1.5
	UHM 20 TX+	70–130	100–160	120–180	0.03–0.1	0.03–0.15	0.01–0.15	0.5–4	0.1–2.5	0.05–1.5
Stainless steel (VI) 220–330 HB	UHM 20	30–70	30–80	30–80	0.002–0.095	0.002–0.014	0.005–0.014	0.5–4	0.1–2.5	0.05–1.5
	UHM 20 HPX	70–90	80–120	80–150	0.002–0.095	0.002–0.014	0.005–0.014	0.5–4	0.1–2.5	0.05–1.5
	UHM 20 TX+	60–80	70–110	70–130	0.002–0.095	0.002–0.014	0.005–0.014	0.5–4	0.1–2.5	0.05–1.5
Titanium (IV) –	UHM 20	40–60	50–70	60–80	0.002–0.095	0.002–0.014	0.005–0.014	0.5–4	0.1–2.5	0.05–1.5
	UHM 20 HPX	50–100	60–120	60–140	0.002–0.095	0.002–0.014	0.005–0.014	0.5–4	0.1–2.5	0.05–1.5
	UHM 20 TX+	40–80	60–120	60–120	0.002–0.095	0.002–0.014	0.005–0.014	0.5–4	0.1–2.5	0.05–1.5
Aluminum (VII) 60–130 HB	UHM 20	100–500	120–500	160–500	0.1–0.3	0.02–0.25	0.005–0.20	0.5–5	0.1–3	0.05–1.5
	UHM 20 HPX	110–170	130–600	170–600	0.1–0.3	0.02–0.25	0.005–0.20	0.5–5	0.1–3	0.05–1.5
	UHM 20 TX+	100–160	130–600	160–600	0.1–0.3	0.02–0.25	0.005–0.20	0.5–5	0.1–3	0.05–1.5
Brass / lead-free brass (VIII) –	UHM 20	80–200	90–200	140–500	0.1–0.3	0.02–0.15	0.005–0.10	0.5–5	0.1–3	0.05–1.5
	UHM 20 HPX	90–220	100–250	130–600	0.1–0.3	0.02–0.15	0.005–0.10	0.5–5	0.1–3	0.05–1.5
	UHM 20 TX+	90–210	100–240	120–600	0.1–0.3	0.02–0.15	0.005–0.10	0.5–5	0.1–3	0.05–1.5
Synthetics reinforced/composites (IX) –	UHM 20	–	–	–	–	–	–	–	–	–
	UHM 20 HPX	–	–	–	–	–	–	–	–	–
	UHM 20 TX+	–	–	–	–	–	–	–	–	–
Hard materials (X) 45–70 HRC	UHM 20	–	–	–	–	–	–	–	–	–
	UHM 20 HPX	–	–	–	–	–	–	–	–	–
	UHM 20 TX+	–	–	–	–	–	–	–	–	–

* With radial infeed, reduce the feed rate by 30–50 %.

Note

- In order to achieve good results, oil cooling is recommended, preferably at high pressure, with approx. 60 bar. Too much pressure can have a negative influence on chip formation.
- With stable conditions, the use of holders with integrated cooling "IC" and optimum cooling can generally increase the cutting data by up to 30 %.



■ **Utilis AG, Precision Tools**

Kreuzlingerstrasse 22, CH-8555 Müllheim, Switzerland
Phone +41 52 762 62 62, Fax +41 52 762 62 00
info@utilis.com, www.utilis.com